

Cilindros electromecánicos Serie 6E

Tamaños 32, 40, 50, 63, 80, 100

CILINDROS ELECTROMECÁNICOS SERIE 6E



Los cilindros de la Serie 6E son actuadores mecánicos lineales con vástago, en los que el movimiento giratorio, generado por un motor, se convierte en un movimiento lineal por medio de un tornillo de bolas recirculantes. Disponible en 6 tamaños, la Serie 6E tiene dimensiones basadas en la norma ISO 15552 y por lo tanto, es posible utilizar los accesorios de montaje de los cilindros neumáticos.

Los cilindros están equipados con un imán que hace posible el uso externo de sensores magnéticos (Serie CST y CSH), permitiendo operaciones como posicionamiento o lecturas de carrera extra a realizarse. La serie 6E está equipada con kits de interfaz específicos, que permiten conectar el motor, tanto en línea como en paralelo. Altas precisiones y fácil montaje hacen a la serie 6E la solución ideal para diferentes aplicaciones, especialmente para sistemas de multi-posición.

- » Conforme a la norma ISO 15552
- » Sistema de múltiples posiciones con la transmisión del movimiento por medio de un tornillo de bolas recirculantes
- » Posibilidad de conectar el motor en línea o paralelo
- » Amplia gama de interfaces del motor
- » Pre-lubricación permanente (libre de mantenimiento)
- » Alta repetibilidad de posicionamiento
- » Reducción de la holgura axial
- » Posibilidad de uso de sensores magnéticos
- » Sistema de anti-rotación integrado del vástago
- » IP40 / IP65
- » Amplia gama de accesorios de fijación
- » Compatible con las unidades de guía anti-rotación de la Serie 45

DATO GENERALES

Construcción	cilindro electromecánico con tornillo de bolas recirculantes
Diseño	perfil con vástago laminado roscado basados en la norma ISO 15552
Operación	actuador multi-posición con movimiento lineal de alta precisión
Tamaños	32, 40, 50, 63, 80, 100
Carreras (min - max)	100 ÷ 1500 mm
Función antirotacion	con almohadillas anti-fricción en tecnopolímero
Montaje	brida delantera / trasera, con pies, con muñón delantero / trasero / giratorio
Montaje de motor	en línea y paralelo
Temperatura de funcionamiento	0°C ÷ 50°C
Temperatura de almacenamiento	-20°C ÷ 80°C
Clase de protección	IP40 / IP65
Lubricacion	No es necesario. Se realiza una pre-lubricación en el cilindro.
Máx. contragolpe de inversión	0.02 mm
Repetibilidad	± 0.02
Ciclo de trabajo	100%
Máxima rotación	± 0.4°
Uso con sensores externos	ranuras en tres lados para sensores modelo CSH y CST

TABLA DE CARRERAS ESTÁNDAR

Las carreras intermedias están disponibles bajo petición.

CARRERAS ESTANDAR											
Tamaño	100	200	300	400	500	600	700	800	1000	1200	1500
32	x	x	x	x	x						
40	x	x	x	x	x	x	x				
50	x	x	x	x	x	x		x	x		
63	x	x	x	x	x			x	x	x	
80	x	x	x	x	x			x	x	x	x
100	x	x	x	x	x			x	x	x	x

EJEMPLO DE CODIFICACIÓN

6E	032	BS	0200	P05	A
6E	SERIE				
032	TAMAÑO: 032 = 32 040 = 40 050 = 50		063 = 63 080 = 80 100 = 100		
BS	DISEÑO: BS = tornillo de bolas recirculantes				
0200	CARRERA: 100 ÷ 1200 mm				
P05	PASO DE TORNILLO: P05 = 5 mm P10 = 10 mm P16 = 16 mm (sólo para el tamaño 40) P20 = 20 mm (sólo para el tamaño 50)		P25 = 25 mm (sólo para el tamaño 63) P32 = 32 mm (sólo para el tamaño 80) P40 = 40 mm (sólo para el tamaño 100)		
A	CONSTRUCCIÓN: A = estándar con tuerca de vástago				
	VERSIÓN: = IP40 (no disponible para tallas 80 y 100) P = IP65 (__ __) = barra de pistón extendida de __ __ mm				

CARACTERÍSTICAS MECÁNICAS

Size	32	32	40	40	40	50	50	50	63	63	63	80	80	80	80	100	100	100	100	
BS screw diameter [mm]	12	12	16	16	16	20	20	20	25	25	25	32	32	32	32	40	40	40	40	
BS screw pitch (p) [mm]	5	10	5	10	16	5	10	20	5	10	25	5	10	20	32	5	10	20	40	
Dynamic load coefficient (C)	[N]	6600	4400	12000	8500	9150	14900	11300	7800	17700	20500	11300	26300	52500	28200	26100	35100	55900	45300	55900
Max admissible load (C _{max})	[N]	525 ^(A)	440 ^(A)	950 ^(A)	850 ^(A)	1070 ^(A)	1180 ^(A)	1130 ^(A)	980 ^(A)	1405 ^(A)	2050 ^(A)	1535 ^(A)	2085 ^(A)	5250 ^(A)	3550 ^(A)	3845 ^(A)	2785 ^(A)	5590 ^(A)	5705 ^(A)	8875 ^(A)
Max applicable torque	[Nm]	2.50	2.80	5.50	6.50	8.20	9.10	10.90	13.60	16.60	19.90	24.90	30	36	30	36	60	60	60	60
Max linear speed*	[m/s]	0.56	1.12	0.42	0.84	1.33	0.33	0.67	1.33	0.27	0.53	1.33	0.23	0.47	0.94	1.50	0.19	0.38	0.75	1.50
Max rotational speed	[rpm]	6670	6670	5000	5000	5000	4000	4000	4000	3200	3200	3200	2810	2810	2810	2810	2250	2250	2250	2250
Max acceleration	[m/s ²]	25	25	25	25	25	25	25	25	25	25	25	25	25	25	25	25	25	25	25

* varía de acuerdo a la carrera (ver gráficos representando la maxima velocidad del cilindro)

MATERIALES SERIE 6E

CILINDROS ELECTROMECÁNICOS SERIE 6E

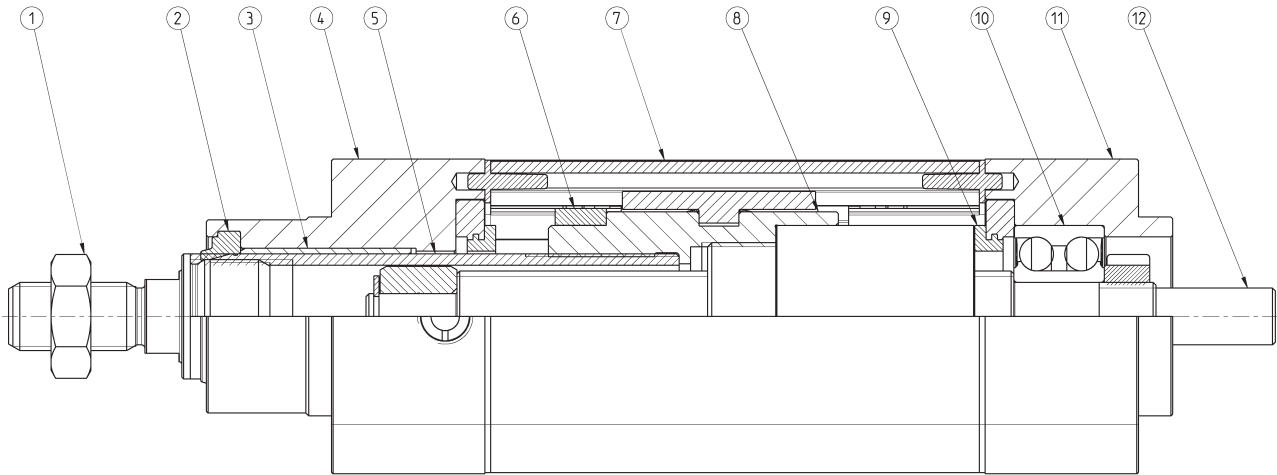

LISTA DE COMPONENTES	
PARTES	MATERIALES
1. Tuerca de vástago	Acero zincado
2. Sello vástago	PU
3. Buje	Tecnopolímero
4. Cabezal delantero	Aluminio anodizado
5. Vástago	Acero inoxidable
6. Imán	Plastoferrita
7. Extrusión de perfil	Aluminio anodizado
8. Tornillo del elemento de guía BS	Aluminio
9. Sello de final carrera	NBR
10. Rodamiento	Acero
11. Cabezal trasero	Aluminio anodizado
12. Tornillo de bola	Acero

ACCESORIOS PARA CILINDROS SERIE 6E



Articulación esférica Mod. GY



Tuerca vástago Mod. U



Perno Mod. S

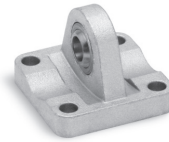

Basculante con artic. esférica Mod. R

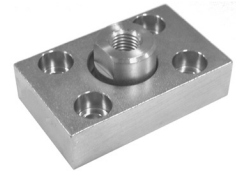

Placa de acoplamiento Mod. GKF



Horquilla con rotula Mod. GA

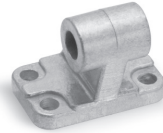

Muñon macho de 90° Mod. ZC

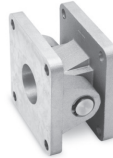

Combinación de accesorios Mod. C+L+S

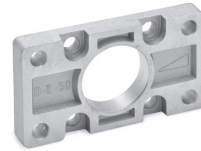

Placa rectangular frontal Mod. D-E



Horquilla autoalineante Mod. GK



Pie de montaje Mod. B-6E

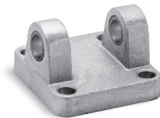

Basculante trasero hembra Mod. C y C-H

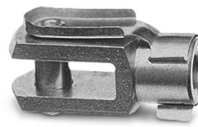

Horquilla Mod. G

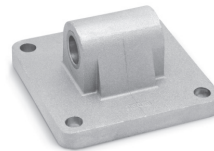

Basculante trasero macho Mod. L



Montaje lateral Mod. BG



Campana para conexión axial Mod. CM

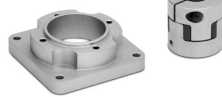

Brida para conexión axial Mod. FM



Kit para conexión axial Mod. AM



Kit para conexión paralela Mod. PM

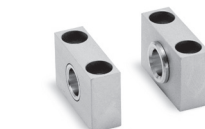
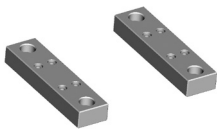
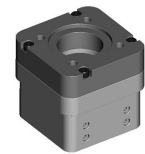

Basculante delantero Mod. FN

Soporte para basculante Mod. BF



Guías anti-giro Serie 45



Todos los accesorios son suministrados por separado, a excepción de la tuerca de bloqueo para el vástago del pistón Mod. U

COMO CALCULAR LA VIDA DEL CILINDRO

Para realizar un correcto dimensionamiento del cilindro Serie 6E, usted necesita considerar algunos hechos.

Entre ellos, los más importantes son:

- Dinámica del sistema
- Ciclo de funcionamiento y pausa
- Ambiente de trabajo
- Requisitos generales de rendimiento: repetibilidad, precisión, consistencia, etc.

CALCULAR LA VIDA útil EN ROTACIONES

dónde:

$$L_r = \left(\frac{C}{F_m \cdot f_w} \right)^3 \cdot 10^6$$

L_r = Vida útil del cilindro en número de rotaciones del tornillo de bolas BS

C = Coeficiente dinámico de carga del cilindro [N]

F_m = Fuerza axial promedio aplicada [N]

f_w = Coeficiente de seguridad según las condiciones de trabajo

CÁLCULO DE LA VIDA útil EN KM

dónde:

$$L_{km} = \frac{L_r \cdot p}{10^6}$$

L_{km} = Vida útil del cilindro en km [km]

p = paso del tornillo de bolas BS [mm]

CÁLCULO DE LA VIDA útil EN HORAS

dónde:

$$L_h = \frac{L_r}{n_m \cdot 60}$$

L_h = Vida útil del cilindro en horas

n_m = número medio de revoluciones del tornillo de bolas BS [Rpm]

APLICACIÓN	ACELERACIÓN [m/s ²]	VELOCIDAD [m/s]	CICLO DE TRABAJO	COEFICIENTE f_w
liviana	< 5.0	< 0.5	< 35%	1.0 ÷ 1.25
normal	5.0 ÷ 15.0	0.5 ÷ 1.0	35% ÷ 65%	1.25 ÷ 1.5
pesada	> 15.0	> 1.0	> 65%	1.5 ÷ 3.0

ANÁLISIS DEL CICLO DE TRABAJO Y LAS PAUSAS DEL SISTEMA

El análisis del ciclo de trabajo y de las pausas del sistema es esencial para calcular el promedio de las cargas axiales F_m y el número de revoluciones medias n_m que actúan sobre el cilindro. Normalmente, el ciclo de trabajo se compone por fases y por cada fase, podemos tener una aceleración, velocidad constante o desaceleración.

CALCULO DEL PROMEDIO DE LA FUERZA AXIAL

$$F_m = \sqrt[3]{\frac{(F_{a1}^3 \cdot n_{a1} \cdot t_{a1}) + (F_{vc1}^3 \cdot n_{vc1} \cdot t_{vc1}) + (F_{d1}^3 \cdot n_{d1} \cdot t_{d1}) + \dots + (F_{an}^3 \cdot n_{an} \cdot t_{an}) + (F_{vcn}^3 \cdot n_{vcn} \cdot t_{vcn}) + (F_{dn}^3 \cdot n_{dn} \cdot t_{dn})}{(n_{a1} \cdot t_{a1}) + (n_{vc1} \cdot t_{vc1}) + (n_{d1} \cdot t_{d1}) + \dots + (n_{an} \cdot t_{an}) + (n_{vcn} \cdot t_{vcn}) + (n_{dn} \cdot t_{dn})}}$$

CALCULO DEL PROMEDIO DEL NUMERO DE REVOLUCIONES

$$n_m = \left\{ \frac{(n_{a1} \cdot t_{a1}) + (n_{vc1} \cdot t_{vc1}) + (n_{d1} \cdot t_{d1}) + \dots + (n_{an} \cdot t_{an}) + (n_{vcn} \cdot t_{vcn}) + (n_{dn} \cdot t_{dn})}{t_{a1} + t_{vc1} + t_{d1} + \dots + t_{an} + t_{vcn} + t_{dn}} \right\}$$

La tabla que se muestra a continuación, indica los valores de aceleración, velocidad y desaceleración para cada fase.

		F [N]	n [rpm]	tiempo %
FASE 1	Aceleración	Fa1	na1	ta1
	Velocidad constante	Fvc1	nvc1	tvc1
	Desaceleración	Fd1	nd1	td1
FASE 2	Aceleración	Fa2	na2	ta2
	Velocidad constante	Fvc2	nvc2	tvc2
	Desaceleración	Fd2	nd2	td2
FASE "n -1"	Aceleración	Fan-1	nan-1	tan-1
	Velocidad constante	Fvcn-1	nvcn-1	tvcn-1
	Desaceleración	Fdn-1	ndn-1	tdn-1
FASE "n"	Aceleración	Fan	nan-1	tan-1
	Velocidad constante	Fvcn	nvcn-1	tvcn-1
	Desaceleración	Fdn	ndn-1	tdn-1
TOTAL				100%

EJEMPLO DE APLICACIÓN

Fase 1	$F_{a1} = 142 \text{ N};$ $n_{a1} = 630 \text{ rpm};$ $t_{a1} = 0,7 \text{ %};$	$F_{vc1} = 98 \text{ N};$ $n_{vc1} = 1260 \text{ rpm};$ $t_{vc1} = 12,9 \text{ %};$	$F_{d1} = 54 \text{ N};$ $n_{d1} = 630 \text{ rpm};$ $t_{d1} = 0,7 \text{ %};$
Fase 2	$F_{a2} = 616 \text{ N};$ $n_{a2} = 450 \text{ rpm};$ $t_{a2} = 4,8 \text{ %};$	$F_{vc2} = 589 \text{ N};$ $n_{vc2} = 900 \text{ rpm};$ $t_{vc2} = 33,3 \text{ %};$	$F_{d2} = 562 \text{ N};$ $n_{d2} = 450 \text{ rpm};$ $t_{d2} = 4,8 \text{ %};$
Fase 3	$F_{a3} = 997 \text{ N};$ $n_{a3} = 240 \text{ rpm};$ $t_{a3} = 7,1 \text{ %};$	$F_{vc3} = 981 \text{ N};$ $n_{vc3} = 480 \text{ rpm};$ $t_{vc3} = 28,6 \text{ %};$	$F_{d3} = 965 \text{ N};$ $n_{d3} = 240 \text{ rpm};$ $t_{d3} = 7,1 \text{ %};$

de esta manera es posible determinar:

$$K_1 = (F_{a1}^3 \cdot n_{a1} \cdot t_{a1}) + (F_{vc1}^3 \cdot n_{vc1} \cdot t_{vc1}) + (F_{d1}^3 \cdot n_{d1} \cdot t_{d1}) \quad n_1 = (n_{a1} \cdot t_{a1}) + (n_{vc1} \cdot t_{vc1}) + (n_{d1} \cdot t_{d1}) \quad T_1 = t_{a1} + t_{vc1} + t_{d1}$$

$$K_2 = (F_{a2}^3 \cdot n_{a2} \cdot t_{a2}) + (F_{vc2}^3 \cdot n_{vc2} \cdot t_{vc2}) + (F_{d2}^3 \cdot n_{d2} \cdot t_{d2}) \quad n_2 = (n_{a2} \cdot t_{a2}) + (n_{vc2} \cdot t_{vc2}) + (n_{d2} \cdot t_{d2}) \quad T_2 = t_{a2} + t_{vc2} + t_{d2}$$

$$K_3 = (F_{a3}^3 \cdot n_{a3} \cdot t_{a3}) + (F_{vc3}^3 \cdot n_{vc3} \cdot t_{vc3}) + (F_{d3}^3 \cdot n_{d3} \cdot t_{d3}) \quad n_3 = (n_{a3} \cdot t_{a3}) + (n_{vc3} \cdot t_{vc3}) + (n_{d3} \cdot t_{d3}) \quad T_3 = t_{a3} + t_{vc3} + t_{d3}$$

Concluyendo sabemos que:

$$F_m = \sqrt[3]{\frac{(K_1 + K_2 + K_3)}{(n_1 + n_2 + n_3)}} = 596,64 \text{ N}$$

$$n_m = \frac{n_1 + n_2 + n_3}{T_1 + T_2 + T_3} = 685,7 \text{ rpm}$$

		F [N]	n [rpm]	tiempo %
FASE 1	Aceleración	142	630	0.7
	Velocidad constante	98	1260	12.9
	Desaceleración	54	630	0.7
FASE 2	Aceleración	616	450	4.8
	Velocidad constante	589	900	33.3
	Desaceleración	562	450	4.8
FASE 3	Aceleración	997	240	7.1
	Velocidad constante	981	480	28.6
	Desaceleración	965	240	7.1
TOTAL				100.0

CÁLCULO DEL PAR MOTOR [NM]

F_A = Fuerza total que actúa desde el exterior [N]
 F_E = Fuerza aplicada externamente [N]
 g = Aceleración gravitacional (9.81 m / s²)
 m_E = Masa del cuerpo a mover [kg]
 μ = Coeficiente de fricción de la guía de soporte
 p = Paso del husillo a bolas [mm]
 C_{M1} = Par motor debido a agentes externos [Nm]

$$C_{TOT} = C_{M1} + C_{M2} + C_{M3}$$

$$F_A = F_E + \mu \cdot m_E \cdot g$$

$$C_{M1} = \frac{F_A \cdot p}{2\pi \cdot 1000}$$

J_{TOT} = Momento de inercia de los componentes rotativos [kg · m²]
 J_F = Momento de inercia de los componentes rotativos de longitud fija [kg · m²]
 J_V = Momento de inercia de los componentes rotativos de longitud variable [kg · m²]
 K_V = Coeficiente de inercia de los componentes rotativos de longitud variable [kg · mm² / mm]
 C = Carrera del vástago [mm]
 $\dot{\omega}$ = aceleración angular [rad / s²]
 a = Aceleración lineal del husillo de bolas [m / s²]
 C_{M2} = Par motor debido a los componentes rotativos [Nm]

$$J_{TOT} = (J_F + J_V) \cdot 10^{-6}$$

$$J_V = K_V \cdot C$$

$$\dot{\omega} = \frac{a \cdot 2\pi \cdot 1000}{p}$$

$$C_{M2} = J_{TOT} \cdot \dot{\omega}$$

F_{TT} = Fuerza generada por la traslación de los componentes trasladados [N]
 F_{TF} = Fuerza generada por la traslación de los componentes trasladados de longitud fija [N]
 F_{TV} = Fuerza generada por la traslación de componentes trasladados de longitud variable [N]
 m_{c1} = Masa de elementos trasladados con longitud fija [kg]
 K_{TV} = Coeficiente de masa de elementos trasladados de longitud variable [kg / mm]
 C_{M3} = par motor debido a los elementos trasladados [Nm]

$$F_{TT} = F_{TF} + F_{TV}$$

$$F_{TF} = m_{c1} \cdot a$$

$$F_{TV} = K_{TV} \cdot C \cdot a$$

$$C_{M3} = \frac{F_{TT} \cdot p}{2\pi \cdot 1000}$$

Valores de masas y momentos de inercia de componentes fijos y rotativos de 6E

Tamaño	J_f [kg·mm ²]	K_v [kg·mm ² /mm]	m_{c1} [kg]	K_{TV} [kg/m]
32	2.88	0.02	0.15	0.79
40	7.92	0.05	0.43	0.98
50	21.77	0.12	0.70	1.13
63	66.35	0.30	1.07	1.38
80	230.89	0.81	2.25	1.87
100	526.49	1.98	3.94	2.37

Vida del cilindro de acuerdo al promedio de la fuerza axial aplicada

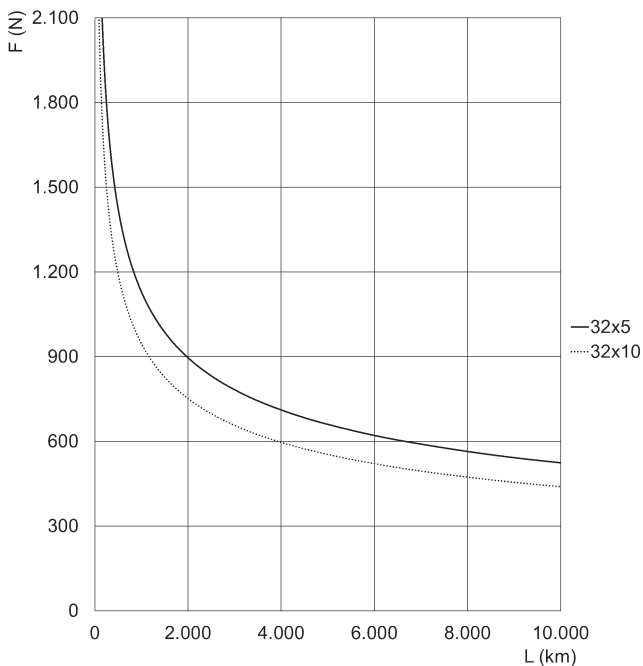

Tamaño 32

F = fuerza axial [N]
L = vida útil [km]

* Curvas calculadas con $f_w = 1$

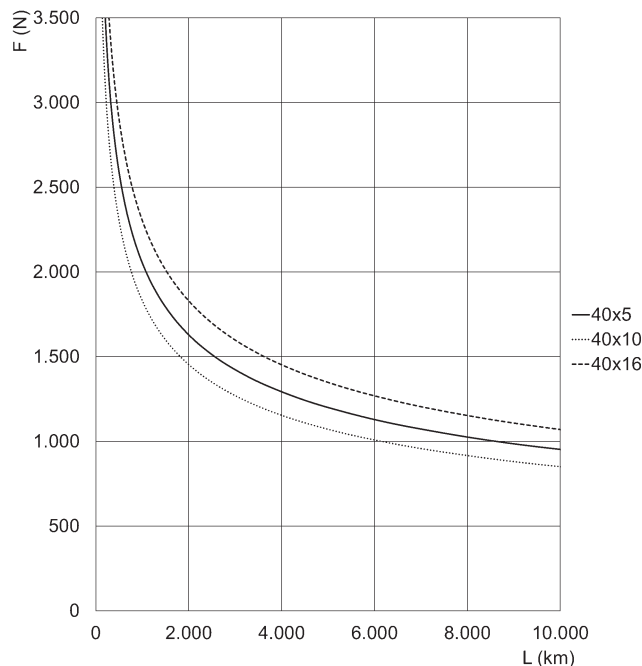

Tamaño 40

F = fuerza axial [N]
L = vida útil [km]

* Curvas calculadas con $f_w = 1$

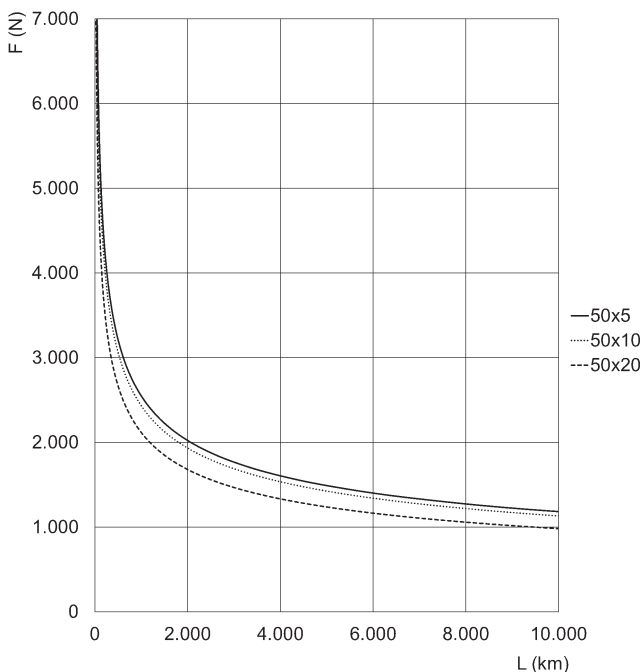

Tamaño 50

F = fuerza axial [N]
L = vida útil [km]

* Curvas calculadas con $f_w = 1$

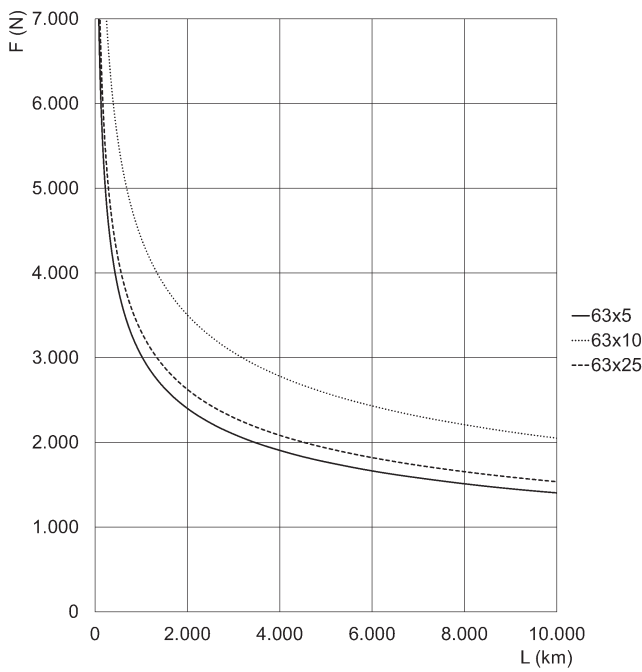

Tamaño 63

F = fuerza axial [N]
L = vida útil [km]

* Curvas calculadas con $f_w = 1$

Vida del cilindro según la fuerza axial media aplicada

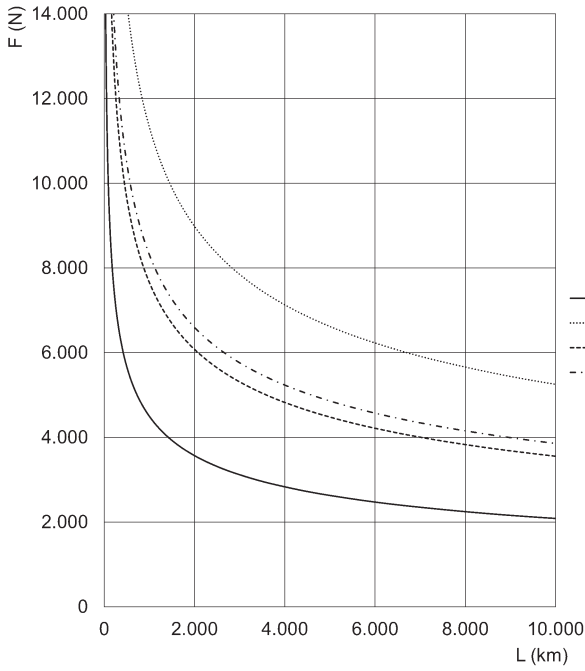

Tamaño 80

F = Fuerza Axial [N]
L = vida [km]

* Curvas calculadas con $f_w = 1$

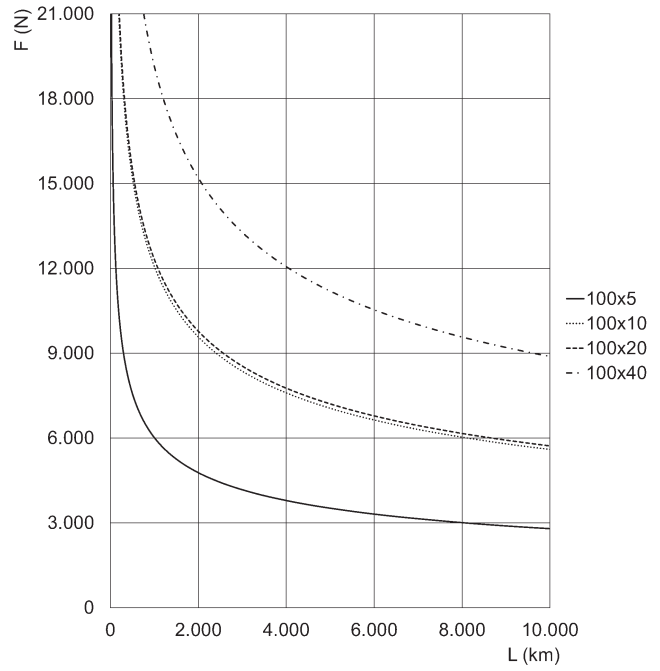

Tamaño 100

F = Fuerza Axial [N]
L = vida [km]

* Curvas calculadas con $f_w = 1$

Velocidad máxima del cilindro según su carrera

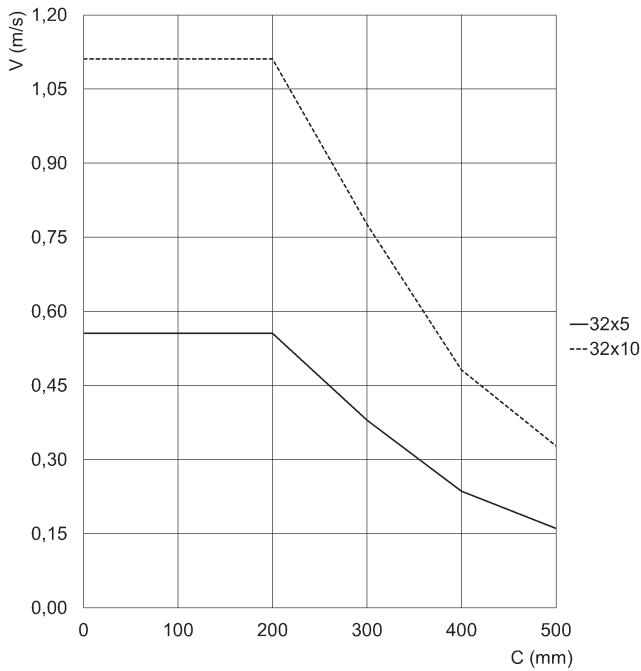

Tamaño 32

v = velocidad [m/s]
c = carrera [mm]

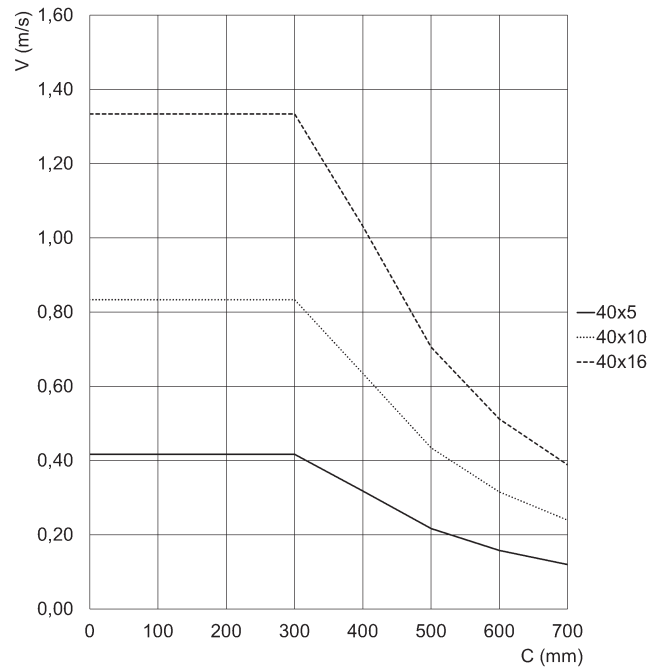

Tamaño 40

v = velocidad [m/s]
c = carrera [mm]

Velocidad maxima del cilindro de acuerdo a la carrera

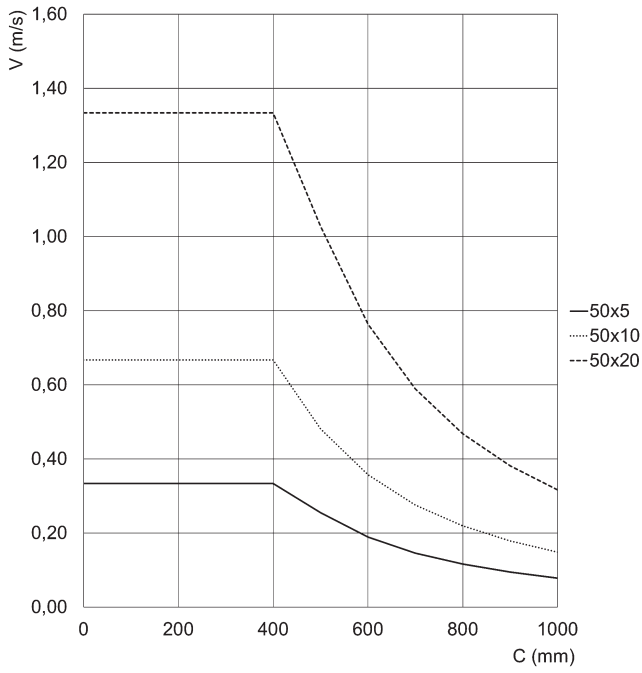

Tamaño 50

V = velocidad [m/s]
c = carrera [mm]

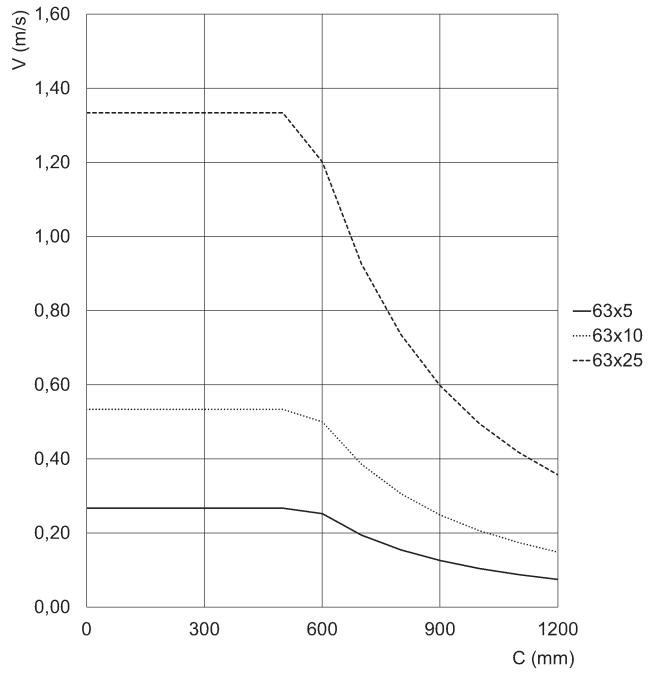

Tamaño 63

V = velocidad [m/s]
c = carrera [mm]

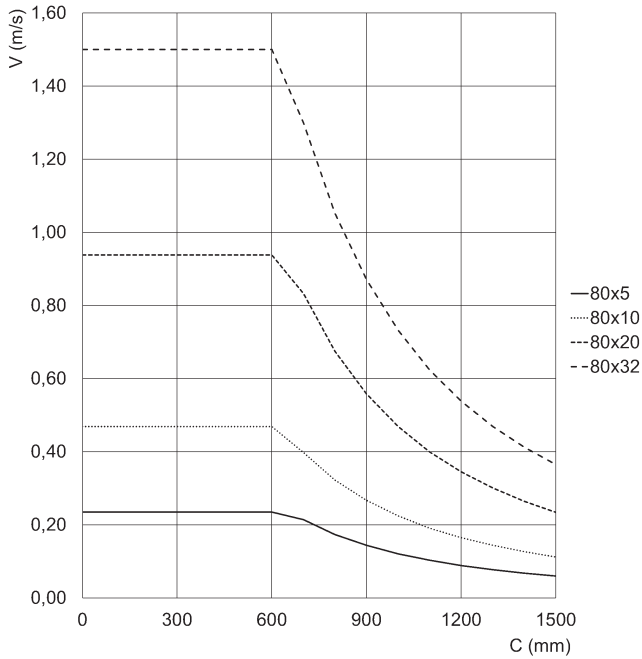

Tamaño 80

V = velocidad [m/s]
c = carrera [mm]

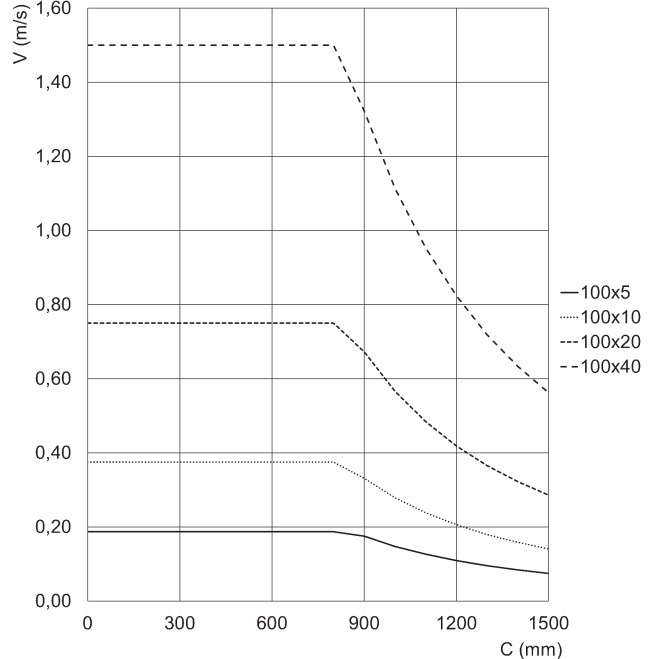

Tamaño 100

V = velocidad [m/s]
c = carrera [mm]

CILINDROS ELECTROMECAÑICOS SERIE 6E

Fuerza máxima del cilindro de acuerdo a la carrera

CILINDROS ELECTROMECÁNICOS SERIE 6E

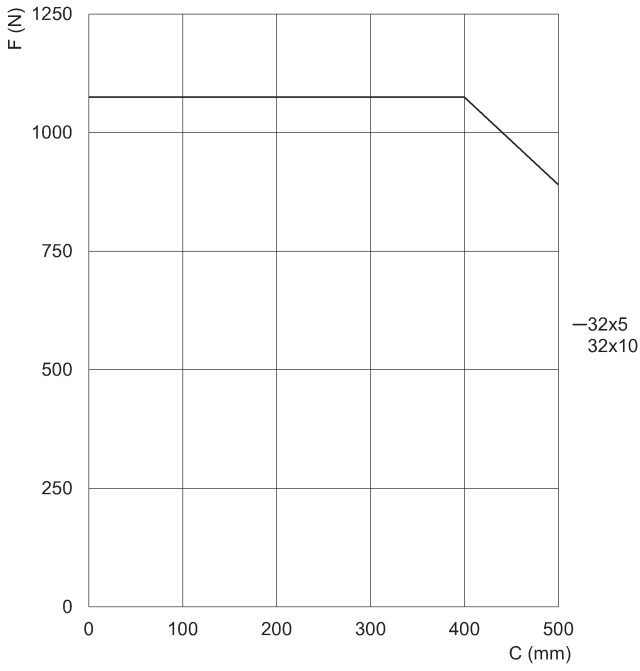

Tamaño 32

F = fuerza axial estática [N]
c = carrera [mm]

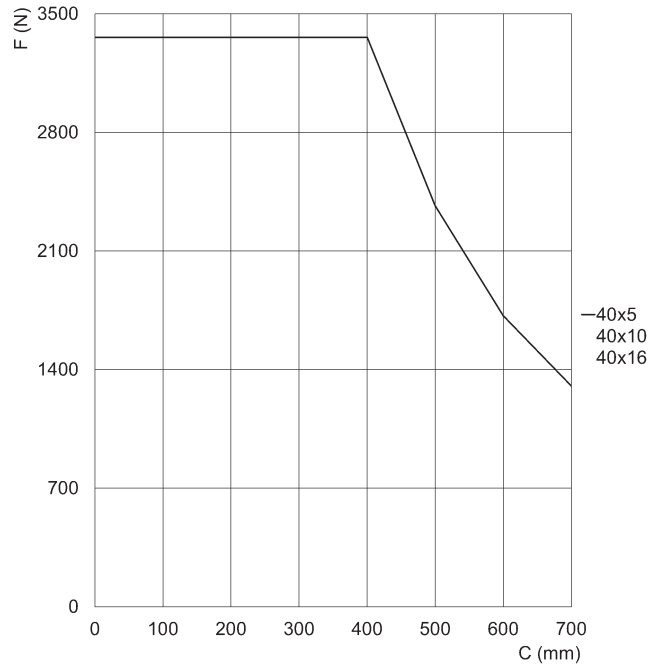

Tamaño 40

F = fuerza axial estática [N]
c = carrera [mm]

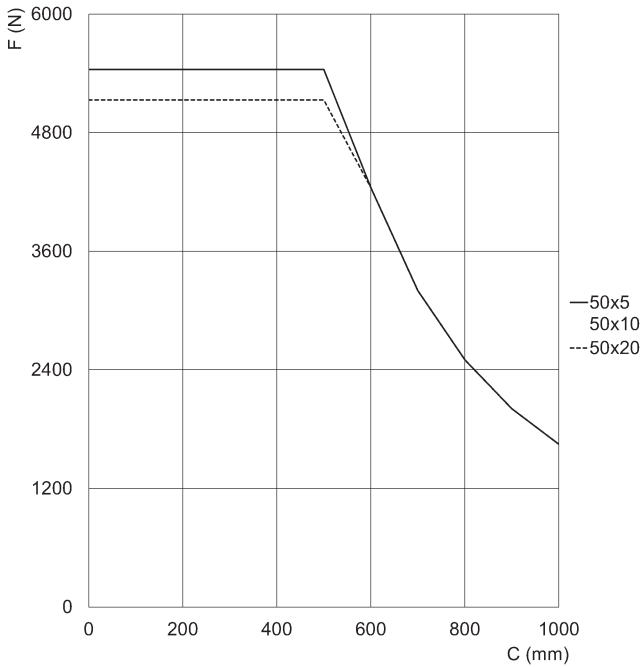

Tamaño 50

F = fuerza axial estática [N]
c = carrera [mm]

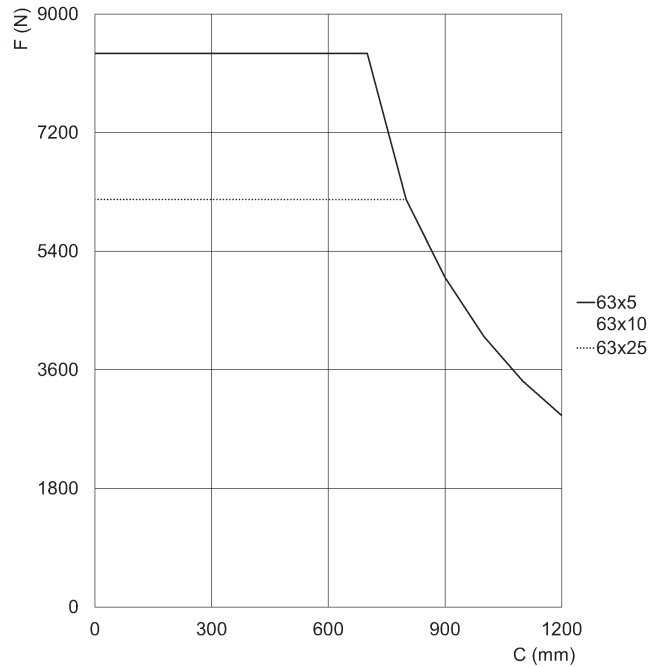

Tamaño 63

F = fuerza axial estática [N]
c = carrera [mm]

Fuerza máxima del cilindro de acuerdo a la carrera

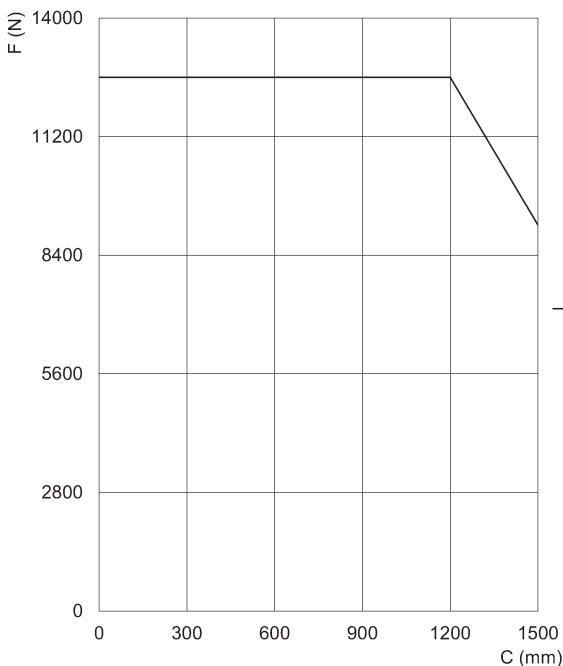

Tamaño 80

F = fuerza axial estática [N]
c = carrera [mm]

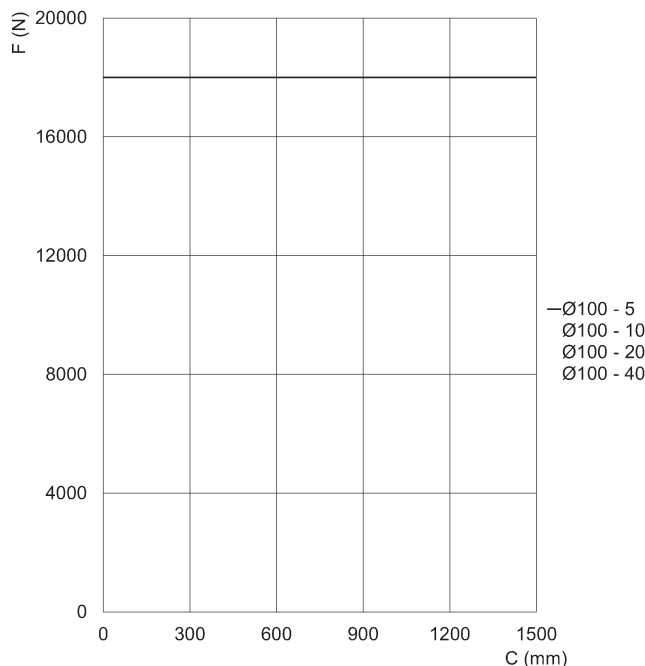

Tamaño 100

F = fuerza axial estática [N]
c = carrera [mm]

CILINDROS ELECTROMECÁNICOS SERIE 6E

Cilindros Serie 6E

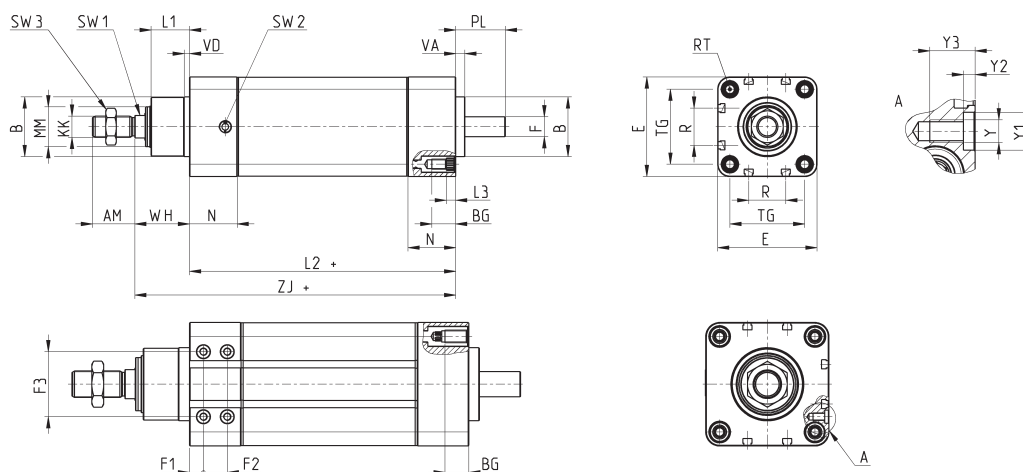

+ = añadir la carrera

DIMENSIONES																															
Tamaño	AM	B	BG	E	F	F1	F2	F3	KK	L1	L2+	L3	MM	N	R	RT	PL	SW1	SW2	SW3	TG	VA	VD	Y	Y1	Y2	Y3	WH	Zj+	peso carrera 0 [g]	peso carrera [kg/m]
32	22	30	16	46.5	8	-	-	-	M10x1.25	20	125	5.5	18	26	13	M6	21	10	G1/8	17	32.5	6	4	-	-	-	-	30	155	1175	3.77
40	24	35	16	55.4	10	-	-	-	M12x1.25	22	142	5.5	22	27	13.5	M6	24	13	G1/8	19	38	6	4	-	-	-	-	33	175	1395	5.30
50	32	40	16	64.9	12	-	-	-	M16x1.5	26	173	5.5	25	36	16	M8	30	17	G1/8	24	46.5	7	4	-	-	-	-	38	211	2280	6.03
63	32	45	16	75	15	-	-	-	M16x1.5	29	201	5.5	30	36	28	M8	38	17	G1/8	24	56.5	7	4	-	-	-	-	42	242.5	3500	9.77
80	40	55	18	93	19	10.5	18	49	M20x1.5	35	211	-	40	39	30	M10	39	22	G1/4	30	72	8	8	M6	10	3	12	49	260	6440	13.70
100	40	65	18	115	24	13	18	62	M20x1.5	38	232	-	50	44	40	M10	42	22	G1/4	30	89	8	8	M8	12	3	16	51	283	10725	20.50

Campana para la conexión axial Mod. CM

Material: aluminio anodizado



Suministrado con:
1x campana
4x tornillos

+ = añadir la carrera

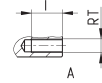
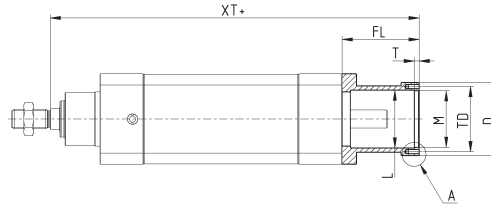
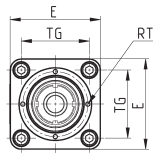

DIMENSIONES

Mod.	Tamaño	XT	E	$\varnothing D$	TG	FL	$\varnothing L$	$\varnothing M^{(H7)}$	T	TD	RT	I	Peso (g)
CM-6E-32	32	201	46.5	42	32.5	46	29	32	4	37	M3	9	100
CM-6E-40	40	224	55.4	52	38	49	36	37	4	43	M3	9	150
CM-6E-50	50	267	64.9	58	46.5	56	39	42	4	49	M4	9	225
CM-6E-63	63	306.5	75	60.5	56.5	64	48	47	4	54	M4	9	280

Brida para conexión axial Mod. FM

Material: aluminio anodizado



Suministrado con:
1x brida
1x montaje flexible
4x tornillos

+ = añadir la carrera

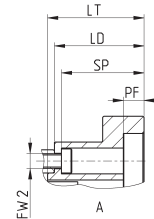
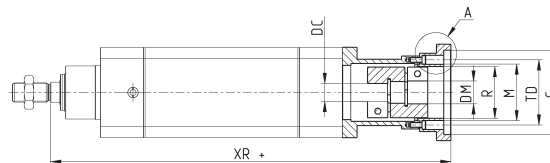
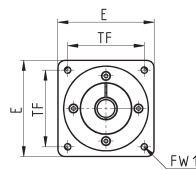

DIMENSIONES

Mod.	Tamaño	Montaje	Motor	XR	$\varnothing C^{(H7)}$	PF	LT	LD	$\varnothing M^{(H7)}$	E	$\varnothing R$	TF	FW1	$\varnothing TD$	SP	FW2	$\varnothing DC$	$\varnothing DM$	Peso (g)
FM-6E-32-0100	32	CM-6E-32	MTB-010-...	210	30	6	11	9	32	42	29	31.8	M3	37	6	3.5	8	8	65
FM-6E-32-0023	32	CM-6E-32	MTS-23-...	208	38.1	5	9	7	32	56.4	29	47.1	M4	37	5	3.5	8	6.35	140
FM-6E-40-0400	40	CM-6E-40	MTB-040-...	242	50	3.5	20	18	37	60	33	49.5	M5	43	3.5	3.5	10	14	140
FM-6E-40-0023	40	CM-6E-40	MTS-23-...	231	38.1	5	9	7	37	56.4	33	47.1	M4	43	5	3.5	10	6.35	215
FM-6E-50-0400	50	CM-6E-50	MTB-040-...	284	50	6	19	17	42	60	37	49.5	M5	49	14	4.5	12	14	210
FM-6E-50-0024	50	CM-6E-50	MTS-24-...	274	38.1	3	9	7	42	58	37	47.1	M4	49	4	4.5	12	8	190
FM-6E-63-0750	63	CM-6E-63	MTB-075-...	332.5	70	6	28	26	47	80	43	63.6	M6	54	24	4.5	15	19	565
FM-6E-63-0024	63	CM-6E-63	MTS-24-...	313.5	38.1	5	9	7	47	60.5	43	47.1	M4	54	5	4.5	15	8	200

Kit para conexión axial Mod. AM



Suministrado con:
 1x montaje
 1x brida
 1x acoplamiento flexible
 4x tornillos para montar el cilindro
 4x tornillos para montar el motor

∅32-40-50-63

∅80-100

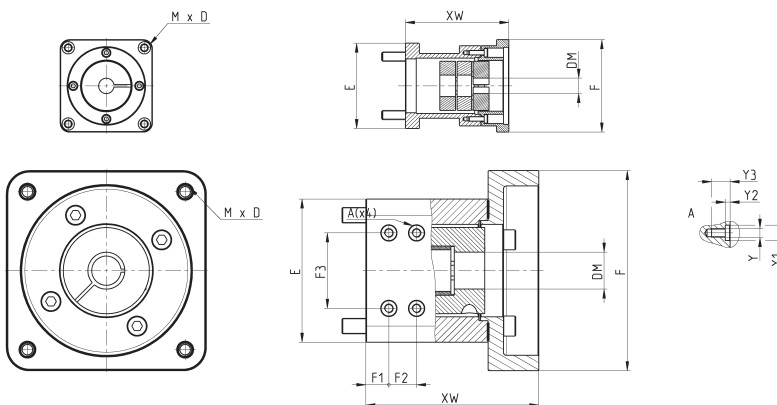

Mod.	Tamaño	Motor	DM	E	F	F1	F2	F3	Y	Y1	Y2	Y3	XW	Peso (g)	η
AM-6E-32-0100	32	IP40 MTB-010-...	8	46.5	42	-	-	-	-	-	-	-	55	165	0.78
AM-6E-32-0100P	32	IP65 MTB-010-...	8	46.5	42	-	-	-	-	-	-	-	55	165	0.78
AM-6E-32-0023	32	IP40 MTS-23-...	6.35	46.5	56.4	-	-	-	-	-	-	-	53	240	0.78
AM-6E-32-0023P	32	IP65 MTS-23-...	6.35	46.5	56.4	-	-	-	-	-	-	-	53	240	0.78
AM-6E-32-0024P	32	IP65 MTS-24-...	8	46.5	60	-	-	-	-	-	-	-	53.5	240	0.78
AM-6E-40-0400	40	IP40 MTB-040-...	14	55.4	60	-	-	-	-	-	-	-	67	290	0.78
AM-6E-40-0400P	40	IP65 MTB-040-...	14	55.4	60	-	-	-	-	-	-	-	67	290	0.78
AM-6E-40-0023	40	IP40 MTS-23-...	6.35	55.4	56.4	-	-	-	-	-	-	-	56	365	0.78
AM-6E-40-0023P	40	IP65 MTS-23-...	6.35	55.4	56.4	-	-	-	-	-	-	-	56	365	0.78
AM-6E-40-0024P	40	IP65 MTS-24-...	8	55.4	60	-	-	-	-	-	-	-	55	365	0.78
AM-6E-50-0400	50	IP40 MTB-040-...	14	64.9	60	-	-	-	-	-	-	-	73	435	0.78
AM-6E-50-0400P	50	IP65 MTB-040-...	14	64.9	60	-	-	-	-	-	-	-	73	435	0.78
AM-6E-50-0750P	50	IP65 MTB-075-...	19	64.9	80	-	-	-	-	-	-	-	86	746	0.78
AM-6E-50-0024	50	IP40 MTS-24-...	8	64.9	58	-	-	-	-	-	-	-	63	415	0.78
AM-6E-50-0024P	50	IP65 MTS-24-...	8	64.9	58	-	-	-	-	-	-	-	63	415	0.78
AM-6E-50-0034P	50	IP65 MTS-34-...	14	64.9	86	-	-	-	-	-	-	-	83	785	0.78
AM-6E-63-0750	63	IP40 MTB-075-...	19	75	80	-	-	-	-	-	-	-	90	845	0.78
AM-6E-63-0750P	63	IP65 MTB-075-...	19	75	80	-	-	-	-	-	-	-	90	845	0.78
AM-6E-63-0024	63	IP40 MTS-24-...	8	75	60.5	-	-	-	-	-	-	-	71	480	0.78
AM-6E-63-0024P	63	IP65 MTS-24-...	8	75	60.5	-	-	-	-	-	-	-	71	480	0.78
AM-6E-63-0034P	63	IP65 MTS-34-...	14	75	86	-	-	-	-	-	-	-	88	1025	0.78
AM-6E-80-1000P	80	IP65 MTB-100-...	24	93	130	15	18	49	M6	10	3.1	12	112.5	2510	0.78
AM-6E-80-0034P	80	IP65 MTS-34-...	14	93	93	15	18	49	M6	10	3.1	12	94.5	1885	0.78
AM-6E-100-1000P	100	IP65 MTB-100-...	24	115	130	15	18	62	M8	12	3.1	18	115.5	3465	0.78
AM-6E-100-0034P	100	IP65 MTS-34-...	14	115	93	15	18	62	M8	12	3.1	18	97.5	2840	0.78

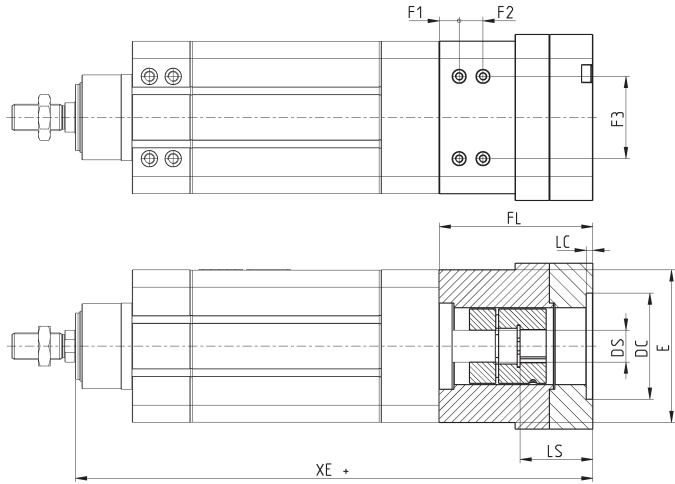
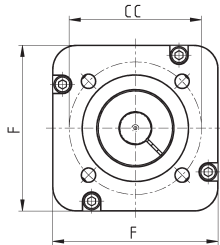
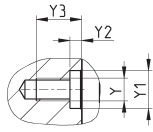
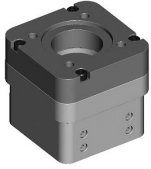

Mod.	Clase de protección	GB	XE+	FL	F	E	DC	LC	CC	F1	F2	F3	Y	Y1	Y2	Y3	DS	LS	Peso (g)
AR-6E-50-R060P	50 IP65	GB-060	288.2	77.2	-	64.9	40	3	52	-	-	-	-	-	-	-	14	35	630
AR-6E-63-R060P	63 IP65	GB-060	339.3	88.6	-	75	40	4	52	-	-	-	-	-	-	-	14	35	1100
AR-6E-80-R080P	80 IP65	GB-080	358	98	-	93	60	5	70	15	18	49	6	10	3.1	12	20	40	2090
AR-6E-100-R120P	100 IP65	GB-120	399.8	116.8	125	115	80	5	100	15	18	62	8	12	3.1	18	25	55	3800

Kit para conexión paralela Mod. PM



- El kit incluye:
 1x tapa delantera
 1x tapa trasera
 2x poleas
 2x juegos de fijación
 1x correa dentada
 1x unidad de tracción de corr.
 4x tornillos para la parte lateral del cilindro
 4x tornillos traseros de la tapa + arandelas de sellado
 6x tornillos de fijación de la tapa
 3x sellos
 1x tapón de cierre
 4x arandelas de sellado del motor

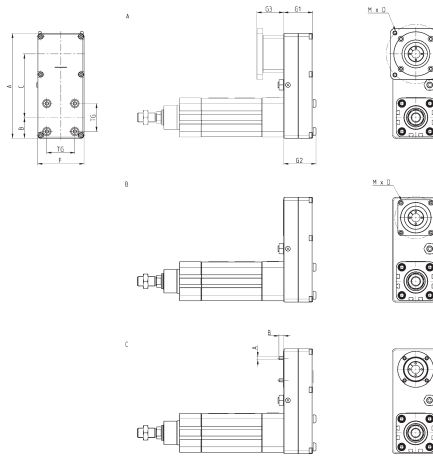

Mod.					G3	A	F	G1	G2	B	C	TG		η
PM-6E-32-0100P	32	IP65	-	MTB-010-...	-	122	54	35	39.5	26.5	65	32.5	450	0.62
PM-6E-32-0024P	32	IP65	-	MTS-24-...	30	122	54	35	39.5	26.5	65	32.5	450	0.62
PM-6E-40-0400P	40	IP65	-	MTB-040-...	-	154	67	46	50.5	30	90	38	960	0.62
PM-6E-40-0024P	40	IP65	-	MTS-24-...	-	154	67	46	50.5	30	90	38	960	0.62
PM-6E-50-0400P	50	IP65	-	MTB-040-...	-	174	77	48	53.5	34.5	105.5	46.5	1375	0.62
PM-6E-50-0034P	50	IP65	-	MTS-34-...	44.5	174	77	48	53.5	34.5	105.5	46.5	1375	0.62
PM-6E-50-R060P	50	IP65	GB-060	MTB-040-...	-	174	77	48	53.5	34.5	105.5	46.5	1375	0.62
PM-6E-63-0750P	63	IP65	-	MTB-075-...	-	192	87	50	55.5	41	107	56.5	1675	0.62
PM-6E-63-0034P	63	IP65	-	MTS-34-...	-	192	87	50	55.5	41	107	56.5	1675	0.62
PM-6E-63-R060P	63	IP65	GB-060	MTB-040-...	-	192	87	50	55.5	41	107	56.5	1675	0.62
PM-6E-80-1000P	80	IP65	-	MTB-100-...	-	310	135	70	77	65	180	72	4457	0.62
PM-6E-80-0034P	80	IP65	-	MTS-34-...	-	310	135	70	77	65	180	72	4457	0.62
PM-6E-80-R080P	80	IP65	GB-080	MTB-075-...	-	310	135	70	77	65	180	72	4457	0.62
PM-6E-100-1000P	100	IP65	-	MTB-100-...	-	310	135	70	77	65	180	89	4457	0.62
PM-6E-100-0034P	100	IP65	-	MTS-34-...	-	310	135	70	77	65	180	89	4457	0.62
PM-6E-100-R080P	100	IP65	GB-080	MTB-075-...	-	310	135	70	77	65	180	89	4457	0.62

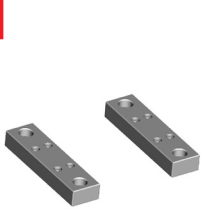

Fourni avec
2 pieds
2 bagues de centrage
8 vis

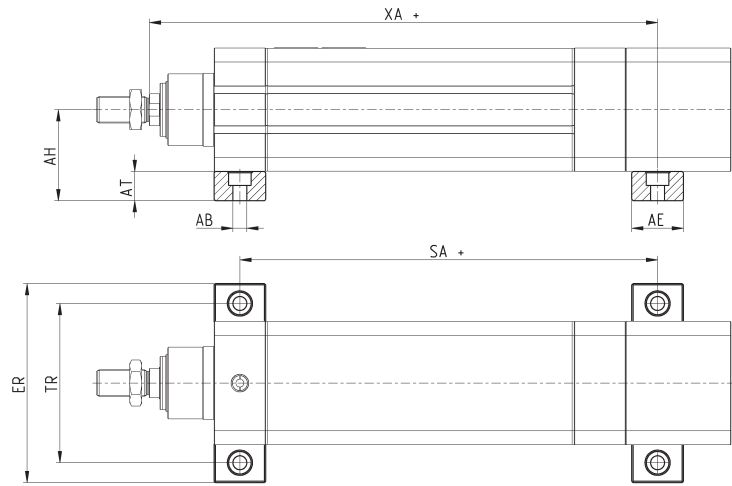

Mod.		XA	AH	AT	ϕ AB	SA	ER	TR	AE	
BA-6E-80	80	283.85	68.5	22	10.5	215.5	150	120	39	630
BA-6E-100	100	306.85	79.5	22	10.5	234	170	140	44	800

Pie de montaje Mod. B-6E



Material: acero galvanizado

Suministrado con:
2x pies
8x tornillos

+ = añadir la carrera

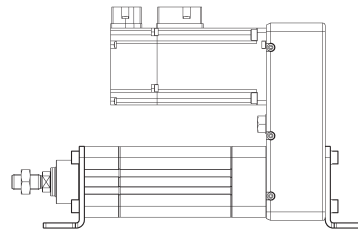
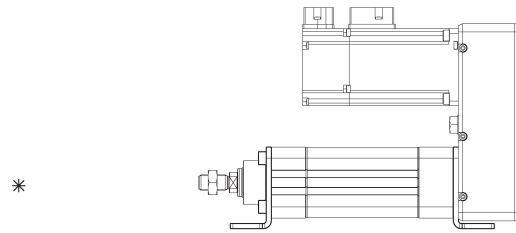
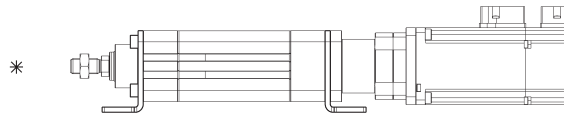
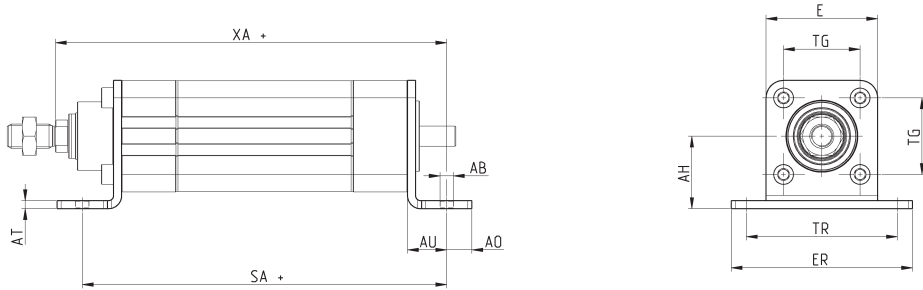

Mod.	Tamaño	SA	XA	AH	TG	TR	AT	AU	AO	AB	ER	E	Peso (g)
B-6E-32	32	164	174.5	32	32.5	65	4	19.5	12.5	6.6	79	46.5	275
B-6E-40	40	181	194.5	36	38	75	4	19.5	12.5	6.6	90	55.4	340
B-6E-50	50	223	236	45	46.5	90	5	25	15	9	110	64.9	635
B-6E-63	63	251	267.5	50	56.5	100	5	25	15	9	120	75	755
B-6E-80	80	278	293.5	68.5	72	120	6	33.5	17.5	10.5	140	93	1300
B-6E-100	100	299	316.5	79.5	89	140	6	33.5	17.5	10.5	170	115	1800

Basculante delantero Mod. FN

Material: acero galvanizado



Suministrado con:
1x basculante con cara plana
4x tornillos

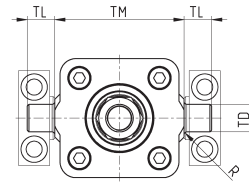
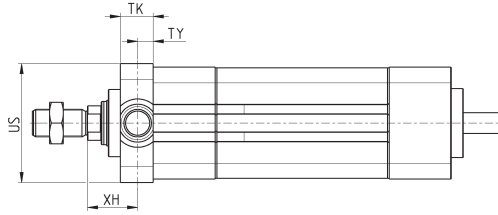

Mod.	∅	TK	TY	XH	US	TL	TM	TD	R	fuerza de torque
FN-32	32	14	6.5	23.5	46	12	50	12	1	5 Nm
FN-40	40	19	9	24	59	16	63	16	1.5	5 Nm
FN-50	50	19	9	29	69	16	75	16	1.6	10 Nm
FN-63	63	24	11.5	30.5	84	20	90	20	1.6	10 Nm
FN-80	80	24	11.5	34.5	102	20	110	20	1.6	15 Nm
FN-100	100	29	14	37	125	25	132	25	2	15 Nm

Soportes para basculante delantero Mod. BF

Material: aluminio

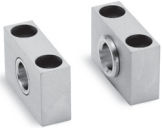

Suministrado con:
2x soportes

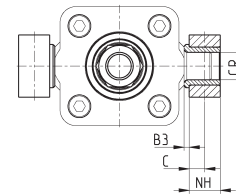
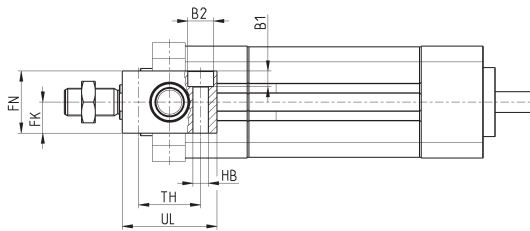

Mod.	∅	CR	NH	C	B3	TH	UL	FK	FN	B1	B2	HB
BF-32	32	12	15	7.5	3	32	46	15	30	6.8	11	6.6
BF-40-50	40 - 50	16	18	9	3	36	55	18	36	9	15	9
BF-63-80	63 - 80	20	20	10	3	42	65	20	40	11	18	11
BF-100-125	100 - 125	25	25	12.5	3.5	50	75	25	50	13	20	14

Placa rectangular frontal Mod. D-E

Material: aluminio

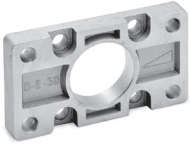

Suministrado con:
1x Placa
4x tornillos

+ = añadir la carrera

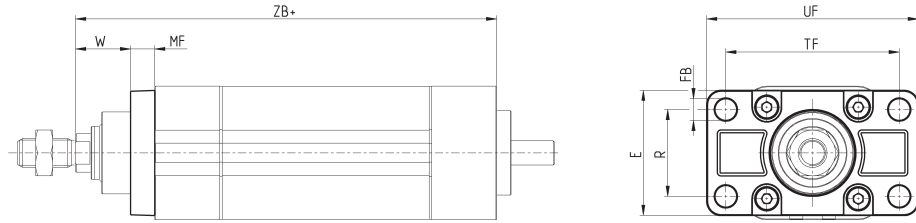

Mod.	Tamaño	W	MF	ZB+	TF	R	UF	E	FB	fuerza de torque
D-E-41-32	32	20	10	155	64	32	86	45	7	6 Nm
D-E-41-40	40	23	10	175	72	36	88	52	9	6 Nm
D-E-41-50	50	26.5	12	211	90	43	110	63	9	13 Nm
D-E-41-63	63	30	12	242.5	100	50	116	73	9	13 Nm
D-E-41-80	80	30	16	260	126	63	148	95	12	15 Nm
D-E-41-100	100	35	16	283	150	75	176	115	14	15 Nm

Montaje lateral Mod. BG

Material: aluminio



Suministrado con:
2x abrazaderas

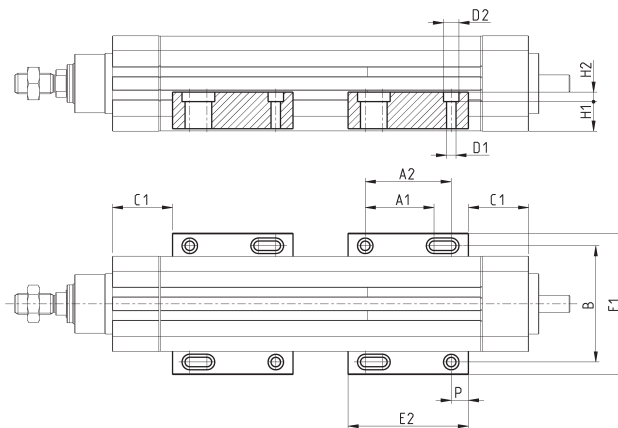

Mod.	Tamaño	C1	E1	E2	P	A1	A2	B	Tornillo	øD1	øD2	H1	H2	Peso (g)
BG-6E-32	32	35	71	70	10	40	50	58.5	M4	4.5	7.5	13.5	4.5	80
BG-6E-40	40	35	82	70	10	40	50	67.5	M5	5.5	9	16.9	5.5	105
BG-6E-50	50	35	93	70	10	40	50	76.5	M6	6.5	10.5	19.4	6.5	125
BG-6E-63	63	35	103.5	70	10	40	50	87	M6	6.5	10.5	18.9	6.5	125
BG-6E-80	80	45	131	90	17.5	50	60	111.6	M8	8.5	14	22.5	8.5	260
BG-6E-100	100	50	153	90	17.5	50	60	133.6	M8	8.5	14	28	8.5	300

Basculante trasero macho Mod. L

Material: aluminio

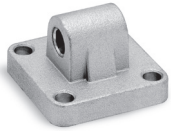

Suministrado con:
1x basculante macho
4x tornillos

+ = añadir la carrera

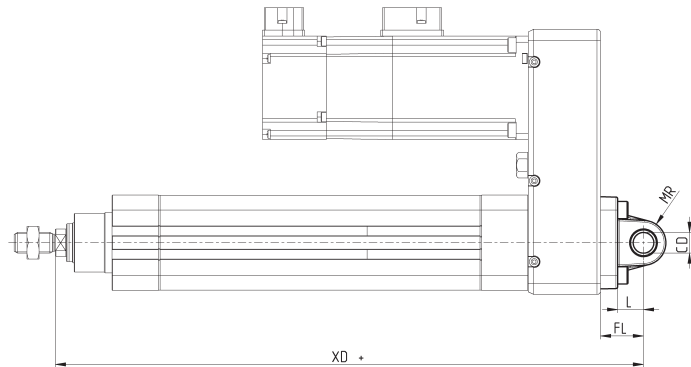
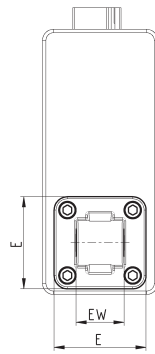

Mod.	Tamaño	∅CD	L	FL	XD+	MR	E	EW	fuerza de torque
L-41-32	32	10	12	22	212	10	45	26	6 Nm
L-41-40	40	12	15	25	246	13	53.5	28	6 Nm
L-41-50	50	12	15	27	286	13	62.5	32	13 Nm
L-41-63	63	16	20	32	324.5	17	73	40	13 Nm
L-41-80	80	16	24	36	373	17	92	50	15 Nm
L-41-100	100	20	29	41	401	21	108.5	60	15 Nm

Basculante trasero hembra Mod. C y C-H

Material: aluminio

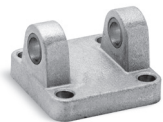

Suministrado con:
1x basculante hembra
4x tornillos

+ = añadir la carrera

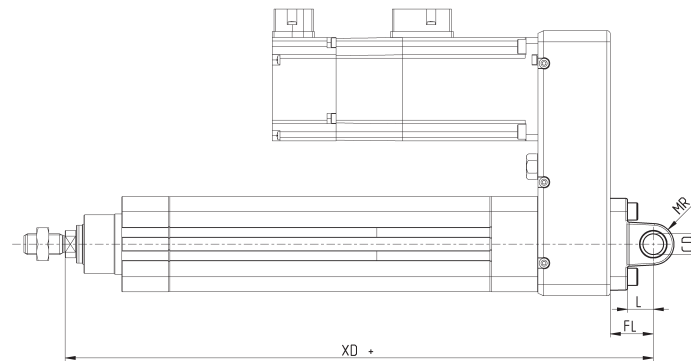
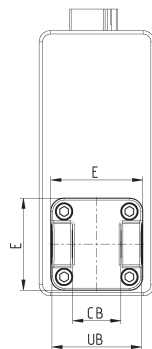

Mod.	Tamaño	∅CD	L	FL	XD+	MR	E	CB	UB	fuerza de torque
C-41-32	32	10	12	22	212	10	45	26	45	6 Nm
C-41-40	40	12	15	25	246	12	53.5	28	52	6 Nm
C-41-50	50	12	15	27	286	13	62.5	32	60	13 Nm
C-H-41-63	63	16	20	32	324.5	17	73	40	70	13 Nm
C-H-41-80	80	16	24	36	373	17	92	50	90	15 Nm
C-H-41-100	100	20	29	41	401	21	108.5	60	110	15 Nm

Combinación de accesorios Mod. C+L+S

Material: aluminio

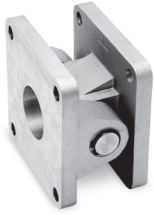

+ = añadir la carrera

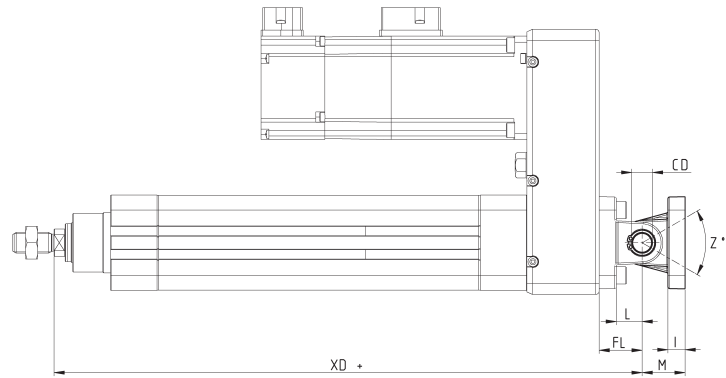
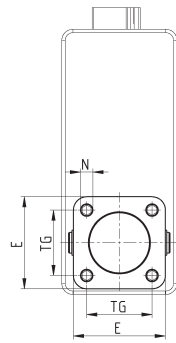

DIMENSIONES												
Mod.	Tamaño	E	TG	°N	XD+	°CD	L	FL	I	M	Z° (max)	fuerza de torque
C+L+S	32	45	32.5	6.5	142	10	12	22	10	22	30	6 Nm
C+L+S	40	53.5	38	6.5	160	12	15	25	10	25	40	6 Nm
C+L+S	50	62.5	46.5	9	170	12	15	27	12	27	25	13 Nm
C+L+S	63	73	56.5	9	190	16	20	32	12	32	36	13 Nm
C+L+S	80	92	72	11	373	16	24	36	12	36	34	15 Nm
C+L+S	100	108.5	89	11	401	20	29	41	12	41	38	15 Nm

Basculante macho de 90° Mod. ZC

CETOP RP 107P
Material: aluminio

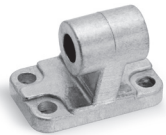

Suministrado con:
1x soporte macho

+ = añadir la carrera

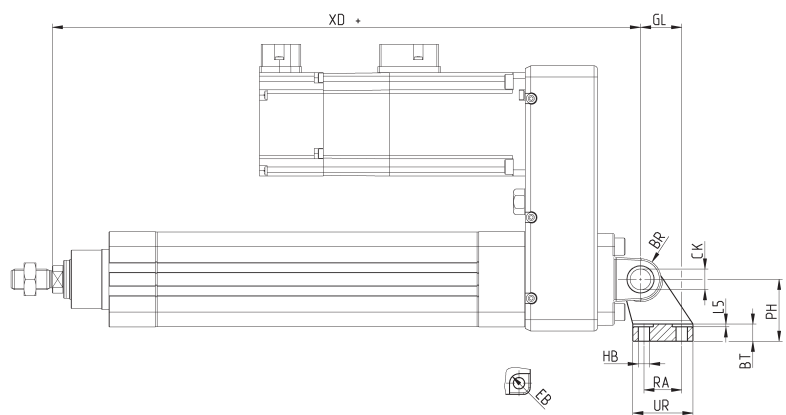
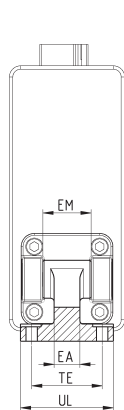

Mod.	Tamaño	°EB	°CK	°HB	XD+	TE	UL	EA	GL	L5	RA	EM	UR	PH	BT	BR
ZC-32	32	11	10	6.6	212	38	51	10	21	1.6	18	26	31	32	8	10
ZC-40	40	11	12	6.6	246	41	54	15	24	1.6	22	28	35	36	10	11
ZC-50	50	15	12	9	286	50	65	16	33	1.6	30	32	45	45	12	13
ZC-63	63	15	16	9	324.5	52	67	16	37	1.6	35	40	50	50	14	15
ZC-80	80	18	16	11	373	66	86	20	47	2.5	40	50	60	63	14	15
ZC-100	100	18	20	11	401	76	96	20	55	2.5	50	60	70	71	17	19

Basculante con articulación Mod. R

Este basculante no cumple con la norma ISO 15552
Material: aluminio

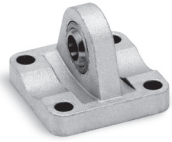

Suministrado con:
1x basculante de articulación
4x tornillos

+ = añadir la carrera

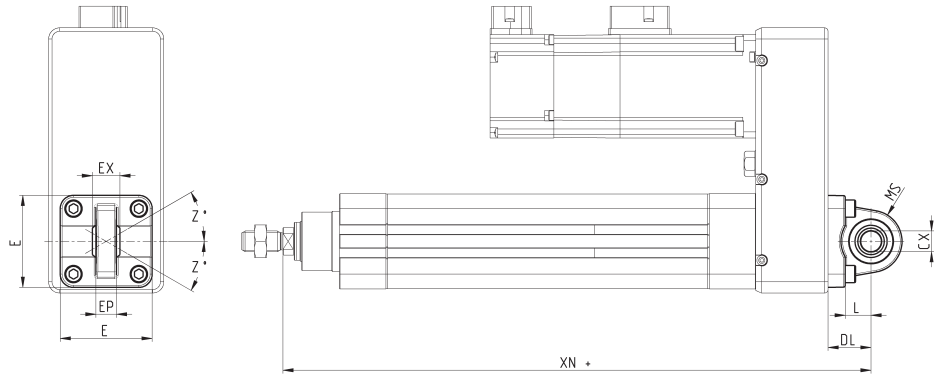

Mod.	Tamaño	∅CX	L	DL	XN+	MS	E	EX	RP	Z	fuerza de torque
R-41-32	32	10	12	22	212	18	45	14	10.5	4°	6 Nm
R-41-40	40	12	15	25	246	18	53.5	16	12	4°	6 Nm
R-41-50	50	12	15	27	286	21	62.5	16	12	4°	13 Nm
R-41-63	63	16	20	32	324.5	23	73	21	15	4°	13 Nm
R-41-80	80	16	24	36	373	28	92	21	15	4°	15 Nm
R-41-100	100	20	29	41	401	30	108.5	25	18	4°	15 Nm

Perno Mod. S



Suministrado con:
1x perno (acero inoxidable
303)
2x Seeger (acero)

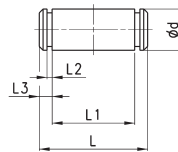

Mod.	Tamaño	∅d	L	L1	L2	L3
S-32	32	10	52	46	1.1	3
S-40	40	12	59	53	1.1	3
S-50	50	12	67	61	1.1	3
S-63	63	16	77	71	1.1	3
S-80	80	16	97	91	1.1	3
S-100	100	20	121	111	1.3	5

Horquilla esférica para vástago Mod. GA



ISO 8139
Material: acero zincado

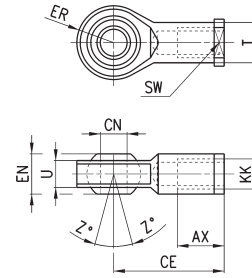

Mod.	ϕ CN ^(H7)	U	EN	ER	AX	CE	KK	ϕ T	Z	SW
GA-32	10	10,5	14	14	20	43	M10X1,25	15	6,5	17
GA-40	12	12	16	16	22	50	M12X1,25	17,5	6,5	19
GA-50-63	16	15	21	21	28	64	M16X1,5	22	7,5	22
GA-80-100	20	18	25	25	33	77	M20x1,5	27,5	7	30

Articulacion esferica Mod. GY



Material: zama y acero galvanizado

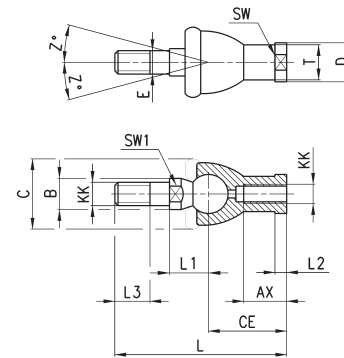

Mod.	Tamaño	KK	AX	CE	E	L	L1	L2	L3	SW	SW1	ϕ B	ϕ C	ϕ D	ϕ T	Z
GY-32	32	M10X1.25	18	35	10	74	19.5	6.5	15	17	11	14	28	19	15	15
GY-40	40	M12X1.25	20	40	12	84	21	6.5	17	19	17	19	32	22	17.5	15
GY-50-63	50-63	M16X1.5	27	50	16	112	27.5	8	23	22	19	22	40	27	22	11
GY-80-100	80-100	M20x1.5	38	63	20	133	31.5	10	25	30	24	27	45	34	27.5	7.5

Horquilla Mod. G



ISO 8140
Material: acero galvanizado

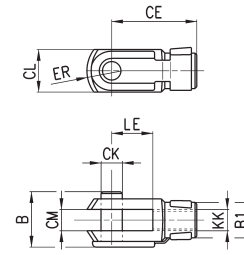

Mod.	ϕ CK	LE	CM	CL	ER	CE	KK	B	ϕ B1
G-25-32	10	20	10	20	12	40	M10 X 1.25	26	18
G-40	12	24	12	24	14	48	M12 X 1.25	32	20
G-50-63	16	32	16	32	19	64	M16 X 1.5	40	26
G-80-100	20	40	20	40	25	80	M20 X 1.5	48	34

Tuerca vástago Mod. U



ISO 4035
Material: acero galvanizado

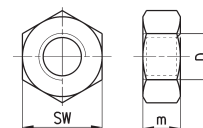

DIMENSIONES			
Mod.	D	m	SW
U-25-32	M10X1.25	6	17
U-40	M12X1.25	7	19
U-50-63	M16X1.5	8	24
U-80-100	M20x1.5	9	30

Accesorio autoalineable Mod. GK

Material: acero galvanizado

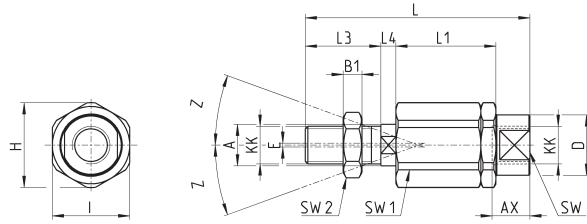

Mod.	Tamaño	KK	L	L1	L3	L4	$\varnothing A$	$\varnothing D$	H	I	SW	SW1	SW2	B1	AX	Z	E
GK-25-32	32	M10x1.25	71.5	35	20	7.5	14	22	32	30	19	12	17	5	22	4	2
GK-40	40	M12x1.25	75.5	35	24	7.5	14	22	32	30	19	12	19	6	22	4	2
GK-50-63	50-63	M16x1.5	104	53	32	10	22	32	45	41	27	20	24	8	30	3	2
GK-80-100	80-100	M20x1.5	119	53	40	10	22	32	45	41	27	20	30	10	37	3	2

Placa de acoplamiento Mod. GKF

Material: acero galvanizado

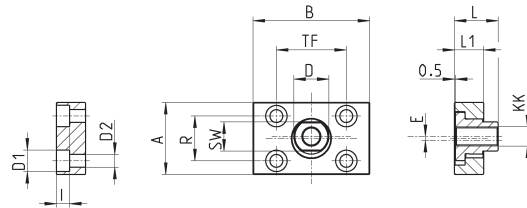
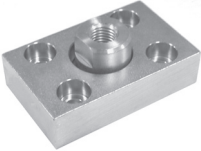

Mod.	Tamaño	KK	A	B	R	TF	L	L1	I	$\varnothing D$	$\varnothing D1$	$\varnothing D2$	SW	E
GKF-25-32	32	M10x1.25	37	60	23	36	22.5	15	6.8	18	11	6.6	15	2
GKF-40	40	M12x1.25	56	60	38	42	22.5	15	9	20	15	9	15	2.5
GKF-50-63	50-63	M16x1.5	80	80	58	58	26.5	15	10.5	25	18	11	22	2.5
GKF-80-100	80-100	M20x1.5	90	90	65	65	32.5	20	13	30.5	20	14	27	2.5

Convertor ranura del sensor Mod. S-CST-500

Suministrado con tubo de 500 mm

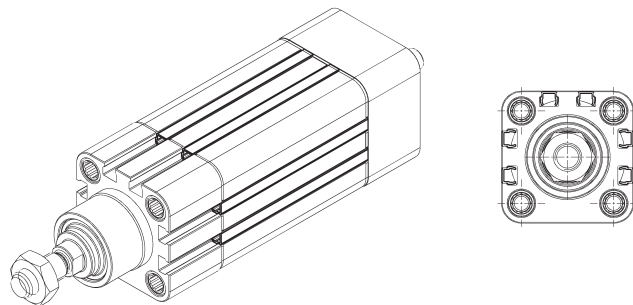

Mod.
S-CST-500